



## Sicherheitshinweise

### Bedeutung der Bedienungsanleitung

Wenn die Bedienungsanleitung und die folgenden Sicherheitshinweise NICHT befolgt werden, können Lebensgefahr durch Stromschlag, Lichtbögen, Brand oder ein Ausfall des Systems die Folge sein.

- Bedienungsanleitung vollständig befolgen.

Das Produkt nur entsprechend dieser Bedienungsanleitung und der technischen Daten anschließen und verwenden.

Die digitale Bedienungsanleitung und die technischen Daten sind unter dem folgenden Link verfügbar:

[www.staubli.com/electrical](http://www.staubli.com/electrical)

### Bestimmungsgemäße Verwendung

Die vorliegenden Handwerkzeuge sind für die ordnungsgemäße Durchführung des Anschlusses von Stäubli PV-Steckverbindern mit PV-Kabeln im spannungsfreien Zustand vorgesehen.

Das Werkzeug ist NICHT geeignet für Arbeiten unter Spannung (IEC 60900).

## Safety instructions

### Importance of the instruction manual

NOT following the instruction manual and safety instructions could result in life-threatening injuries due to electric shock, electric arcs, fire, or failure of the system.

- Follow the entire instruction manual.

Use the product only according to this instruction manual and the technical data.

The digital instruction manual and the technical data are available at:

[www.staubli.com/electrical](http://www.staubli.com/electrical)

### Intended use

The present hand tools are in place to deliver crimp excellence for Stäubli PV connectors with cables. Crimpings shall be carried out only in de-energized state of the cables.

The hand tool is NOT suitable for Live working (IEC 60900).

## Sicherheitshinweis zur Notöffnung der Crimpzange zur Vermeidung von Personenschäden:

### Benötigtes Werkzeug zur Notöffnung der Zange:

Schraubendreher mit einer feinen Spitze z.B. 3 × 75 mm

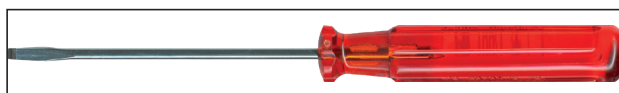

## Safety instructions regarding the emergency opening feature to avoid human injuries:

### Required tool for emergency opening:

Screwdriver with fine tip e.g. 3 × 75mm

### Beschreibung der Notöffnung:



### Description of the emergency opening:

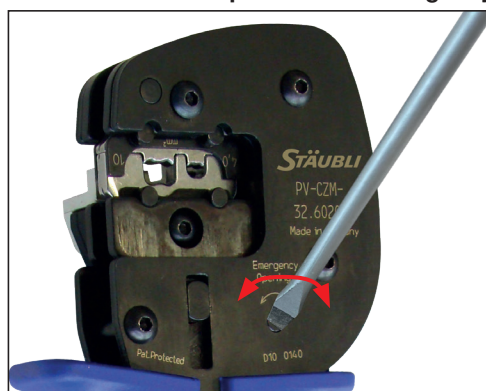

Die Schraube mithilfe eines Schraubendrehers im Gegenuhrzeigersinn oder im Uhrzeigersinn drehen, um die Verriegelung der Zange unmittelbar zu lösen.

Use the screwdriver to turn the screw anti-clockwise or clockwise to a point where the pliers will be disengaged instantly.

### **i** Hinweis:

Nach einer Notöffnung der Crimpzange darf der gerade bearbeitete Crimp nicht mehr verwendet werden.

Nach einer Notöffnung kann die Zange unmittelbar für eine nächste Crimp Herstellung wieder benutzt werden.

### **i** Note:

Once the crimping pliers have been opened using the emergency opening, the metal crimp in process needs to be discarded.

No special action necessary to use the crimping pliers for any next crimp operation following an emergency opening.

Ausführung für MC4

Explanation for MC4

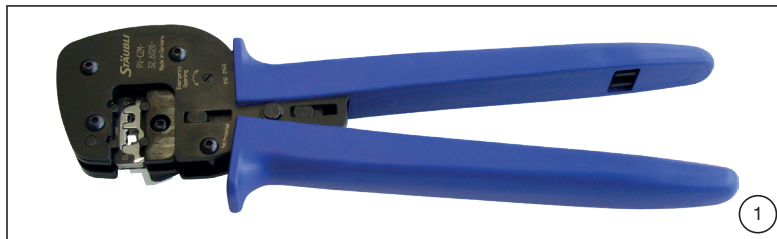

(ill. 1) Crimpzange inkl. Lokator und eingebautem Crimpeinsatz.

(ill. 1) Crimping pliers incl. locator and built-in crimping die.

Typ Type	Leiterquerschnitt Conductor cross section	Offener Crimpkontakt (B-Crimp) Open crimp contacts (B-Crimp)	Geschlossener Crimpkontakt (O-Crimp) Closed crimp contacts (O-Crimp)	Crimpzangen Crimping pliers								Crimpeinsätze Crimping dies								Lokator Locator		
				PV-CZM-18100 32.6020-18100	PV-CZM-19100 32.6020-19100	PV-CZM-22100 32.6020-22100	PV-CZM-23100 32.6020-23100	PV-CZM-20100 32.6020-20100	PV-CZM-21100 32.6020-21100	PV-ES-CZM-18100 32.6021-18100	PV-ES-CZM-19100 32.6021-19100	PV-ES-CZM-22100 32.6021-22100	PV-ES-CZM-23100 32.6021-23100	PV-ES-CZM-20100 32.6021-20100	PV-ES-CZM-21100 32.6021-21100	PV-LOC 32.6040	PV-LOC-B 32.6055	PV-LOC-D 32.6074				
PV-KBT4/2,5...-UR, PV-KST4/2,5...-UR	2.5 mm <sup>2</sup>	•		•	•					•	•						•					
	14 AWG	•		•	•					•	•						•					
PV-KBT4/6...-UR, PV-KST4/6...-UR	4 mm <sup>2</sup>	•		•	•	•		•		•	•	•		•			•	•				
	12 AWG	•		•	•	•		•		•	•	•		•			•	•				
	6 mm <sup>2</sup>	•			•	•			•		•	•			•		•	•				
PV-KBT4/5...-UR, PV-KST4/5...-UR	10 AWG	•			•	•			•		•	•			•		•	•				
	14 AWG		•				•							•					•			
PV-KBT4/5...-UR, PV-KST4/5...-UR	12 AWG		•				•							•					•			
	10 AWG		•				•							•					•			
PV-KBT4/8II-UR, PV-KST4/8II-UR	8 AWG		•			•	•						•	•				•	•			
PV-KBT/10... PV-KST/10...	10 mm <sup>2</sup>	•						•	•						•	•	•					

Pos.	Leiterquerschnitt Cable cross section		geeignet für suitable for
	mm <sup>2</sup>	AWG	
1	1.5	14	PV-KST4/2.5-UR PV-KBT4/2.5-UR
2	2.5		PV-KST4/2.5-UR PV-KBT4/2.5-UR
3	4	12	PV-KST4/6-UR PV-KBT4/6-UR

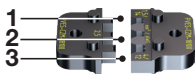

(2)

**Einzelteile**

**(ill. 2 + 3 + 4 + 5 + 6 + 7)**  
Auswechselbare Crimpeinsätze.

**Individual parts**

**(ill. 2 + 3 + 4 + 5 + 6 + 7)**  
Interchangeable crimping dies.

**(ill. 2)**

Crimpbereich Crimping range		Typ Type	Bestell-Nr. Order No.
mm <sup>2</sup>	AWG		
1.5/2.5/4	14/12	PV-ES-CZM-18100	32.6021-18100

**(ill. 2)**

Pos.	Leiterquerschnitt Cable cross section		geeignet für suitable for
	mm <sup>2</sup>	AWG	
4	2.5		PV-KST4/2.5...-UR PV-KBT4/2.5...-UR
5	4	12	PV-KST4/6...-UR PV-KBT4/6...-UR
6	6	10	PV-KST4/6...-UR PV-KBT4/6...-UR



(3)

**(ill. 3)**

Crimpbereich Crimping range		Typ Type	Bestell-Nr. Order No.
mm <sup>2</sup>	AWG		
2.5/4/6	12/10	PV-ES-CZM-19100	32.6021-19100

**(ill. 3)**

Pos.	Leiterquerschnitt Cable cross section		geeignet für suitable for
	mm <sup>2</sup>	AWG	
7	4		PV-KST4/6...-UR PV-KBT4/6...-UR
8	10		PV-KST4/10...-UR PV-KBT4/10...-UR



(4)

**(ill. 4)**

Crimpbereich Crimping range		Typ Type	Bestell-Nr. Order No.
mm <sup>2</sup>	AWG		
4/10		PV-ES-CZM-20100	32.6021-20100

**(ill. 4)**

Pos.	Leiterquerschnitt Cable cross section		geeignet für suitable for
	mm <sup>2</sup>	AWG	
9	6		PV-KST4/6...-UR PV-KBT4/6...-UR
10	10		PV-KST4/10...-UR PV-KBT4/10...-UR



(5)

**(ill. 5)**

Crimpbereich Crimping range		Typ Type	Bestell-Nr. Order No.
mm <sup>2</sup>	AWG		
6/10		PV-ES-CZM-21100	32.6021-21100

**(ill. 5)**

Pos.	Leiterquerschnitt Cable cross section	geeignet für suitable for
	AWG	
11	8	PV-KST4/8II-UR PV-KBT4/8II-UR
12	10	PV-KST4/6...-UR PV-KBT4/6...-UR
13	12	PV-KST4/6...-UR PV-KBT4/6...-UR

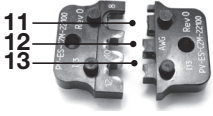

(6)

(ill. 6)

(ill. 6)

Crimpbereich Crimping range	Typ Type	Bestell-Nr. Order No.
AWG		
8/12/10	PV-CZM-22100	32.6020-22100

Pos.	Leiterquerschnitt Cable cross section	geeignet für suitable for
	AWG	
14	8	PV-KST4/8II-UR PV-KBT4/8II-UR
15	10/12	PV-KST4/5...-UR PV-KBT4/5...-UR
16	14	PV-KST4/5...-UR PV-KBT4/5...-UR

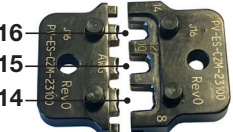

(7)

(ill. 7)

(ill. 7)

Crimpbereich Crimping range	Typ Type	Bestell-Nr. Order No.
AWG		
8/10/12/14	PV-CZM-23100	32.6021-23100



(ill. 8)

(ill. 8)

Lokator PV-LOC  
Bestell-Nr.: 32.6040

Locator PV-LOC  
Order No.: 32.6040



(ill. 9)

(ill. 9)

Lokator PV-LOC-B  
Bestell-Nr.: 32.6055

Locator PV-LOC-B  
Order No.: 32.6055

**i Hinweis:**  
Beim Einsatz des Crimpwerkzeuges PV-CZM-22100 Lokator PV-LOC-B benutzen.

**i Note:**  
When using the crimping pliers PV-CZM-22100, use the locator PV-LOC-B.



(ill. 10)

(ill. 10)

Lokator PV-LOC-D  
Bestell-Nr.: 32.6074

Locator PV-LOC-D  
Order No.: 32.6074

**i Hinweis:**  
Beim Einsatz des Crimpwerkzeuges PV-CZM-23100 Lokator PV-LOC-D benutzen.

**i Note:**  
When using the crimping pliers PV-CZM-23100, use the locator PV-LOC-D.

Ausführung für MC4-Evo 2

Explanation for MC4-Evo 2



**(ill. 11)**  
Crimpzange inkl. Lokator und eingebautem Crimpeinsatz.

**(ill. 11)**  
Crimping pliers incl. locator and built-in crimping die.

Typ Type	Leiterquerschnitt Conductor cross section	Offener Crimpkontakt (B-Crimp) Open crimp contacts (B-Crimp)	Geschlossener Crimpkontakt (O-Crimp) Closed crimp contacts (O-Crimp)	Crimpzangen Crimping pliers			Crimpeinsätze Crimping dies			Lokator Locator
				PV-CZM-40100 32.6020-40100	PV-CZM-41100 32.6020-41100	PV-CZM-42100 32.6020-42100	PV-ES-CZM-40100 32.6021-40100	PV-ES-CZM-41100 32.6021-41100	PV-ES-CZM-42100 32.6021-42100	
PV-KST-EVO 2/2.5...-UR	2.5 mm <sup>2</sup>	•		•	•		•	•		•
PV-KBT-EVO 2/2.5...-UR	14 AWG	•		•	•		•	•		•
PV-KST-EVO 2/6...-UR, PV-KBT-EVO 2/6...-UR	4 mm <sup>2</sup>	•		•	•	•	•	•	•	•
	12 AWG	•		•	•	•	•	•	•	•
	6 mm <sup>2</sup>	•		•	•		•	•		•
PV-KST-EVO 2/10...-UR, PV-KBT-EVO 2/10...-UR	10 AWG	•		•	•		•	•		•
	10 mm <sup>2</sup>	•				•			•	•
	8 AWG	•				•		•		•

Pos.	Leiterquerschnitt Cable cross section		geeignet für suitable for
	mm <sup>2</sup>	AWG	
1	1.5		PV-KST4-EVO 2/2,5...-UR PV-KBT4-EVO 2/2,5...-UR
2	2.5	14	PV-KST4-EVO 2/2,5...-UR PV-KBT4-EVO 2/2,5...-UR
3	4	12	PV-KST4-EVO 2/6...-UR PV-KBT4-EVO 2/6...-UR

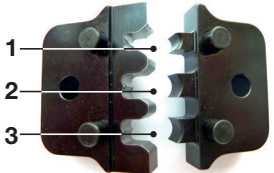

(12)

Pos.	Leiterquerschnitt Cable cross section		geeignet für suitable for
	mm <sup>2</sup>	AWG	
4	2.5	14	PV-KST4-EVO 2/2,5...-UR PV-KBT4-EVO 2/2,5...-UR
5	4	12	PV-KST4-EVO 2/6...-UR PV-KBT4-EVO 2/6...-UR
6	6	10	PV-KST4-EVO 2/6...-UR PV-KBT4-EVO 2/6...-UR

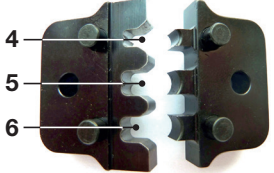

(13)

Pos.	Leiterquerschnitt Cable cross section		geeignet für suitable for
	mm <sup>2</sup>	AWG	
7	4	12	PV-KST4-EVO 2/6...-UR PV-KBT4-EVO 2/6...-UR
8	10	8	PV-KST4-EVO 2/10...-UR PV-KBT4-EVO 2/10...-UR

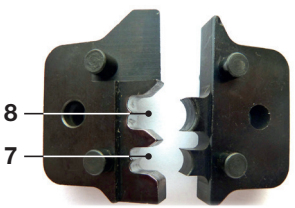

(14)

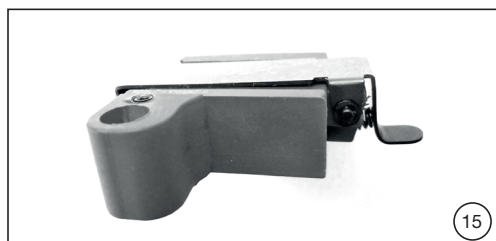

**Einzelteile**

**(ill. 12 + 13 + 14)**  
Auswechselbare Crimpeinsätze.

**(ill. 12)**

Crimpbereich Crimping range		Typ Type	Bestell-Nr. Order No.
mm <sup>2</sup>	AWG		
1.5/2.5/4	14/12	PV-ES-CZM-40100	32.6021-40100

**Individual parts**

**(ill. 12 + 13 + 14)**  
Interchangeable crimping dies.

**(ill. 12)**

**(ill. 13)**

Crimpbereich Crimping range		Typ Type	Bestell-Nr. Order No.
mm <sup>2</sup>	AWG		
2.5/4/6	14/12/10	PV-ES-CZM-41100	32.6021-41100

**(ill. 13)**

**(ill. 14)**

Crimpbereich Crimping range		Typ Type	Bestell-Nr. Order No.
mm <sup>2</sup>	AWG		
4/10	12/8	PV-ES-CZM-42100	32.6021-42100

**(ill. 14)**

**(ill. 15)**  
Locator PV-LOC-C  
Bestell-Nr.: 32.6056

**(ill. 15)**  
Locator PV-LOC-C  
Order no.: 32.6056

**Crimpeinsatz auswechseln**

**Exchanging the crimping die**

**Crimpeinsatz ausbauen**

**Removing the crimping die**



**(ill. 16)**  
Crimpzange schließen.

**(ill. 16)**  
Close the crimping pliers.

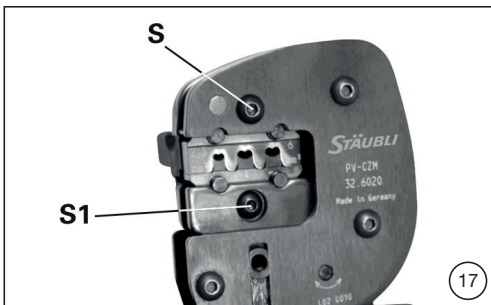

**(ill. 17)**  
Schraube S (lang) und S1 (kurz) komplett herausdrehen.  
Crimpzange öffnen (ganz zusammen-drücken und loslassen).

**(ill. 17)**  
Remove completely both mounting screws: the long S and the short S1.  
Open the crimping pliers (press completely together and release).

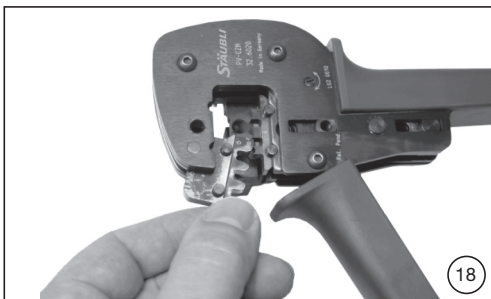

**(ill. 18)**  
Obere Crimpeinsatz herausnehmen.

**(ill. 18)**  
Remove the upper crimping die.

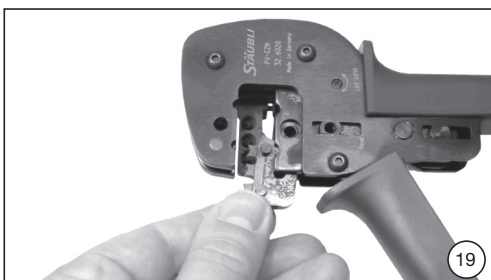

**(ill. 19)**  
Untere Crimpeinsatz herausnehmen.

**(ill. 19)**  
Remove the lower crimping die.



**Crimpeinsatz einbauen**

**Fitting the crimping die**

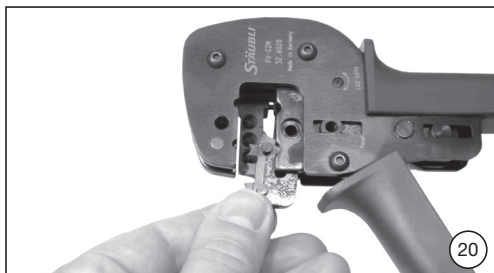

**(ill. 20)**

- Crimpzange öffnen (ganz zusammen-drücken und loslassen).
- Beide Crimpeinsätze einführen.
- Die Beschriftung muss sich auf der gleichen Seite wie die Beschriftung der Crimpzange befinden.
- Crimpzange schliessen und beide Crimpeinsätze festschrauben.
- Schraube an ihrer richtigen Stelle platzieren. Schraubenköpfe nicht verletzen.

**(ill. 20)**

- Open the crimping pliers (press completely together and release).
- Insert both crimping dies.
- The markings must be on the same side as the marking on the crimping pliers.
- Close crimping pliers and screw both crimping dies.
- But take care not to strip screw heads and to put each screw in its proper location.

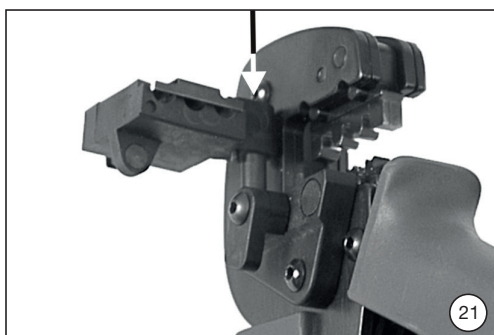

**(ill. 21)**

Lokator in den Führungsstift einlegen.

**(ill. 21)**

Affix locator onto the guide pin.

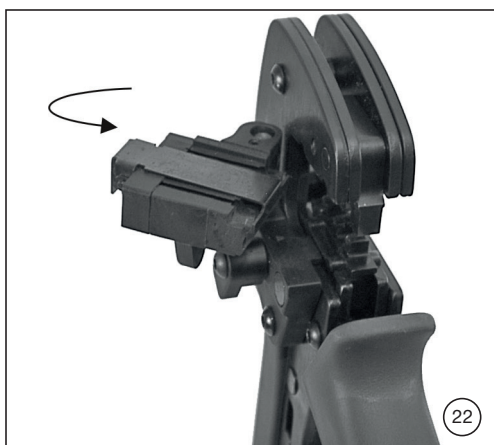

**(ill. 22)**

Lokator umschwenken (wird magnetisch festgehalten).

**(ill. 22)**

Rotate the locator (held magnetically)



**(ill. 23)**

Lokator verriegeln.

**(ill. 23)**

Lock the locator.

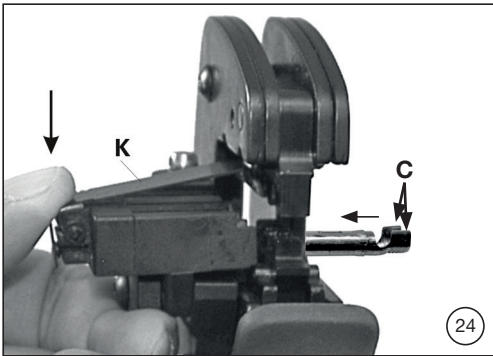

### Crimpen

**(ill. 24)**

- Klemmbügel (K) öffnen und festhalten.
- Kontakt in den passenden Querschnittsbereich legen.
- Crimplaschen (C) nach oben drehen.
- Klemmbügel (K) loslassen.
- Der Kontakt ist fixiert.

### Crimping

**(ill. 24)**

- Open clamp (K) and hold tight.
- Insert the contact in the appropriate cross-section range.
- Turn the crimping flaps (C) upwards.
- Release clamp (K).
- The contact is locked.

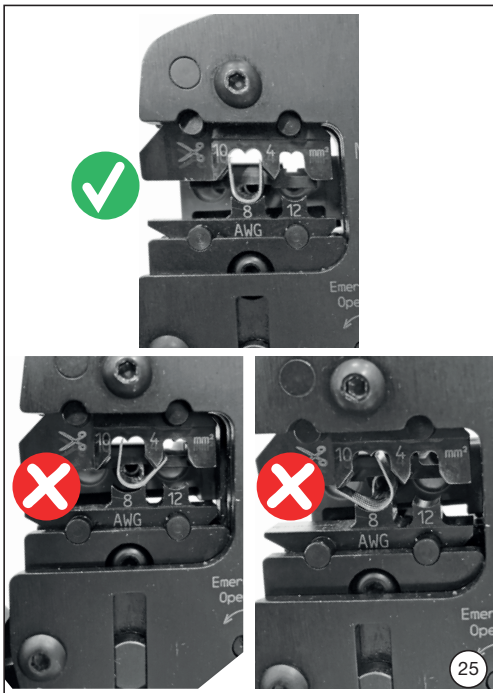

**(ill. 25)**

Prüfen, ob die Crimplaschen noch richtig ausgerichtet sind.

Zange leicht zusammendrücken, so dass die Crimplaschen innerhalb des Crimpeinsatzes liegen.

**(ill. 25)**

Verify if the crimping flaps are still correctly aligned.

Press the pliers gently together until the crimping flaps are properly located within the crimping die.

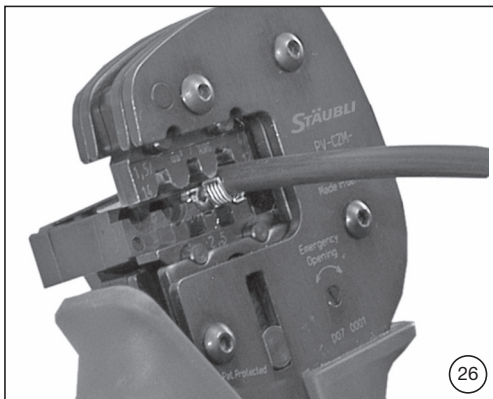

**(ill. 26)**

Abisolierte Leitung einführen bis die Litzen am Klemmbügel anschlagen. Crimpzange ganz schließen.

**(ill. 26)**

Insert the stripped cable end until the cable strands come up against the clamp. Close the crimping pliers completely.

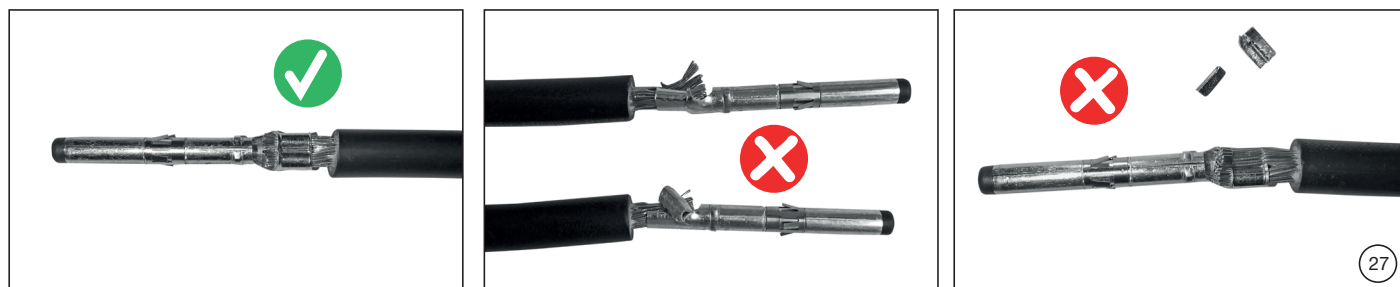

**(ill. 27)**  
Crimping kontrollieren bezüglich der Kriterien, die in IEC 60352-2 beschrieben sind.

Sicherstellen, dass:

- alle Litzen in der Crimphülse eingeschlossen sind.
- die Crimphülse nicht deformiert ist und kein Teil der Crimptaschen fehlt.
- die Crimpung symmetrisch ist.
- auf der Kontaktseite der Crimpung ein „Bündel“ aus Litzen sichtbar ist.

Crimphöhe verifizieren. Typische Werte für die Crimphöhe der Stäubli PV Leitung Flex-Sol-Evo TX und Flex-Sol-Evo DX sind wie folgt:

**(ill. 27)**  
Visually check the crimp according to the criteria written in IEC 60352-2.

Confirm that:

- All of the strands have been captured in the crimp sleeve.
- The crimp sleeve is not deformed or missing any portion of the crimp flaps.
- That the crimp is symmetrical in form.
- A “brush” of conductor strands are visible on the contact side of crimp.

Verify crimp height. Typical values for the crimp height for Stäubli PV cable Flex-Sol-Evo TX and Flex-Sol-Evo DX are listed below:

MC4	MC4-Evo 2	mm <sup>2</sup>	AWG	Offener Crimpkontakt (B-Crimp) Open crimp contacts (B-Crimp)	Geschlossener Crimpkontakt (O-Crimp) Closed crimp contacts (O-Crimp)	Leitung Cable		Crimphöhe Crimp height
PV-KBT4/2,5...-UR PV-KST4/2,5...-UR	PV-KST4-EVO 2/2.5...-UR PV-KBT4-EVO 2/2.5...-UR	2.5	14	•		Flex-Sol-Evo TX 2,5	Flex-Sol-Evo DX 2,5	1.80
PV-KBT4/6...-UR PV-KST4/6...-UR	PV-KST4-EVO 2/6...-UR PV-KBT4-EVO 2/6...-UR	4.0	12	•		Flex-Sol-Evo TX 4,0	Flex-Sol-Evo DX 4,0	2.15
PV-KBT4/6...-UR PV-KST4/6...-UR	PV-KST4-EVO 2/6...-UR PV-KBT4-EVO 2/6...-UR	6.0	10	•		Flex-Sol-Evo TX 6,0	Flex-Sol-Evo DX 6,0	2.40
PV-KBT/10... PV-KST/10...	PV-KST4-EVO 2/10...-UR PV-KBT4-EVO 2/10...-UR	10	8	•		Flex-Sol-Evo TX 10	Flex-Sol-Evo DX 10	3.02
PV-KBT4/5...-UR PV-KST4/5...-UR			14		•		Flex-Sol-Evo DX 2,5	2.20
PV-KBT4/5...-UR PV-KST4/5...-UR			12		•		Flex-Sol-Evo DX 4,0	2.50
PV-KBT4/5...-UR PV-KST4/5...-UR			10		•		Flex-Sol-Evo DX 6,0	2.50
PV-KBT4/8II-UR PVKST4/8II-UR			8		•		Flex-Sol-Evo DX 10	3.12

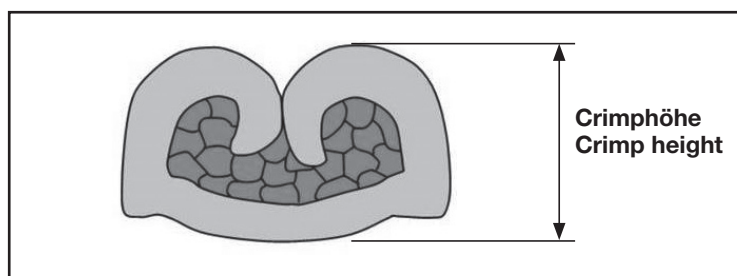

**Gute Crimpverbindung**

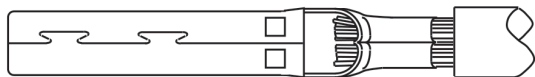

**Good crimp**

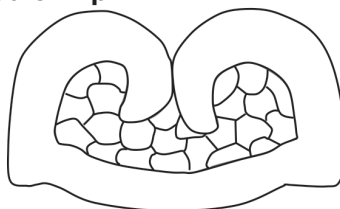

**Schlechte Crimpverbindung:**

- Stanzteile in falsche Richtung gebogen.

**Bad crimp:**

- Stamped parts bent wrongly.

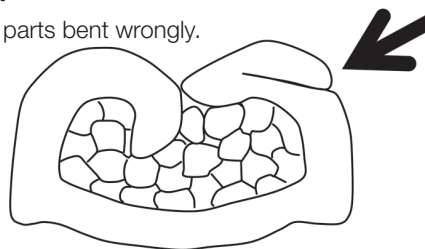
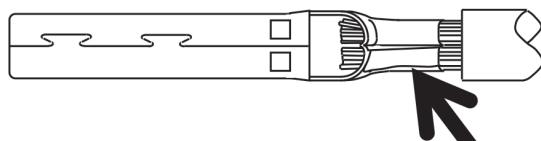

- Werkstoff nach unten geflossen („Flügel“).

- Material flow outwards.

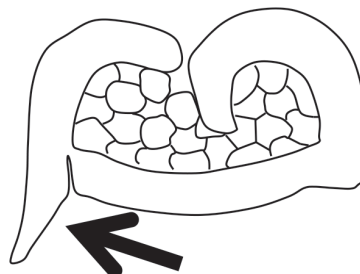
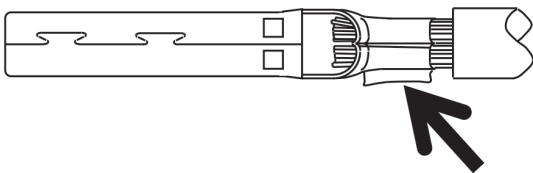

- Crimpverbindung nicht geschlossen.

- Open crimp wings.

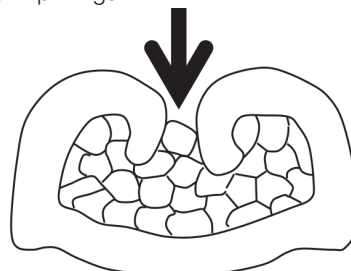
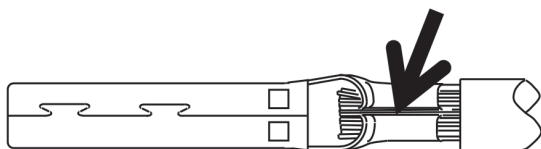

- Nicht gecrimpte Leitungslitzen.

- Not included strands.

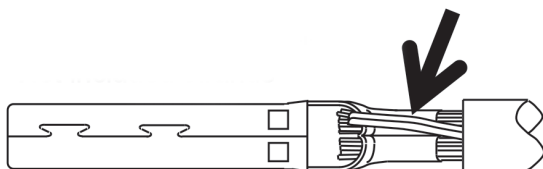

**Hersteller/Manufacturer:**  
**Stäubli Electrical Connectors AG**  
 Stockbrunnenrain 8  
 4123 Allschwil/Switzerland  
 Tel. +41 61 306 55 55  
 Fax +41 61 306 55 56  
 mail ec.ch@staubli.com  
 www.staubli.com/electrical